

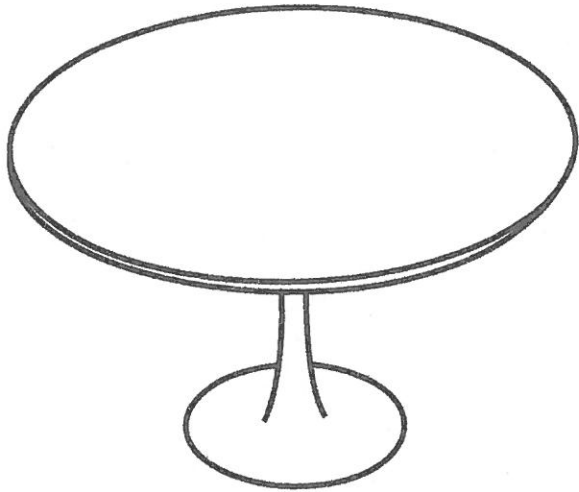









Assembly Instruction



A	 x1	H	 x8
B	 x1	I	 x1
C	 x1		
D	 x1		
E	 x6		
F	 x6		
G	 x8		

①

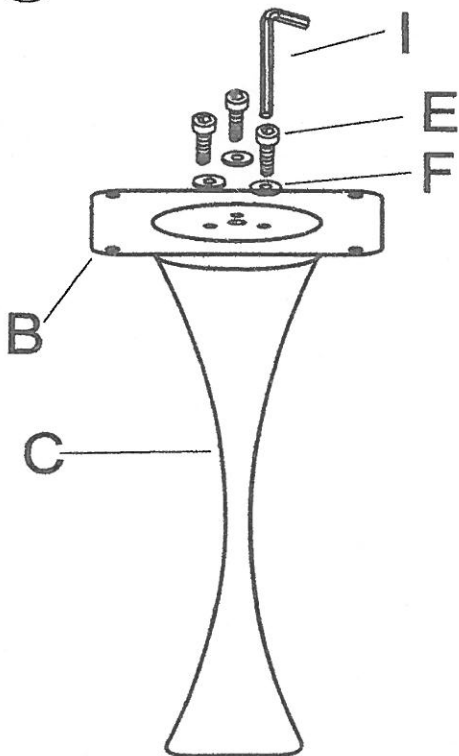

②

