

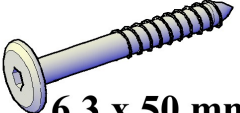

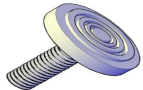

A  **x 8**
6,3 x 50 mm

B  **x 8**

C  **x 4**
6 x 50 mm

D  **x 8**
8 x 30 mm

E  **x 16**
4 x 40 mm

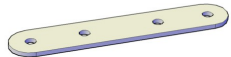
F  **x 2**

G  **x 8**
16 mm

1.

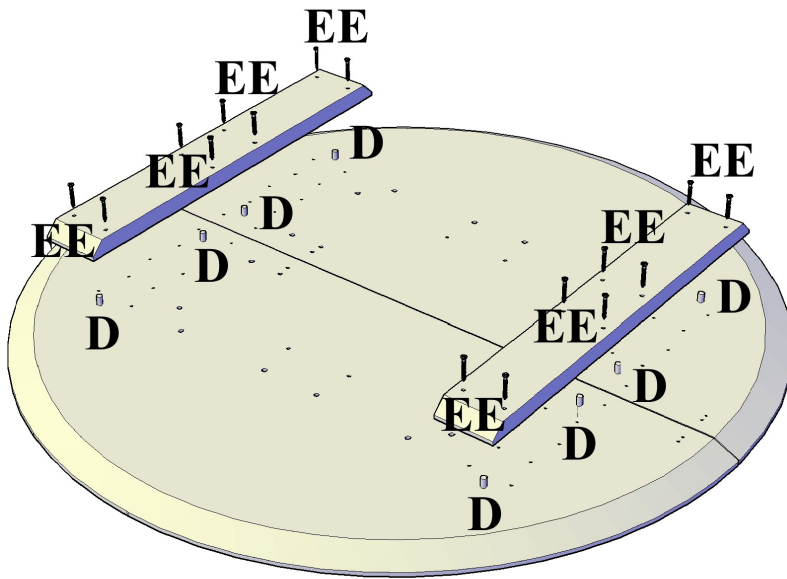

2.

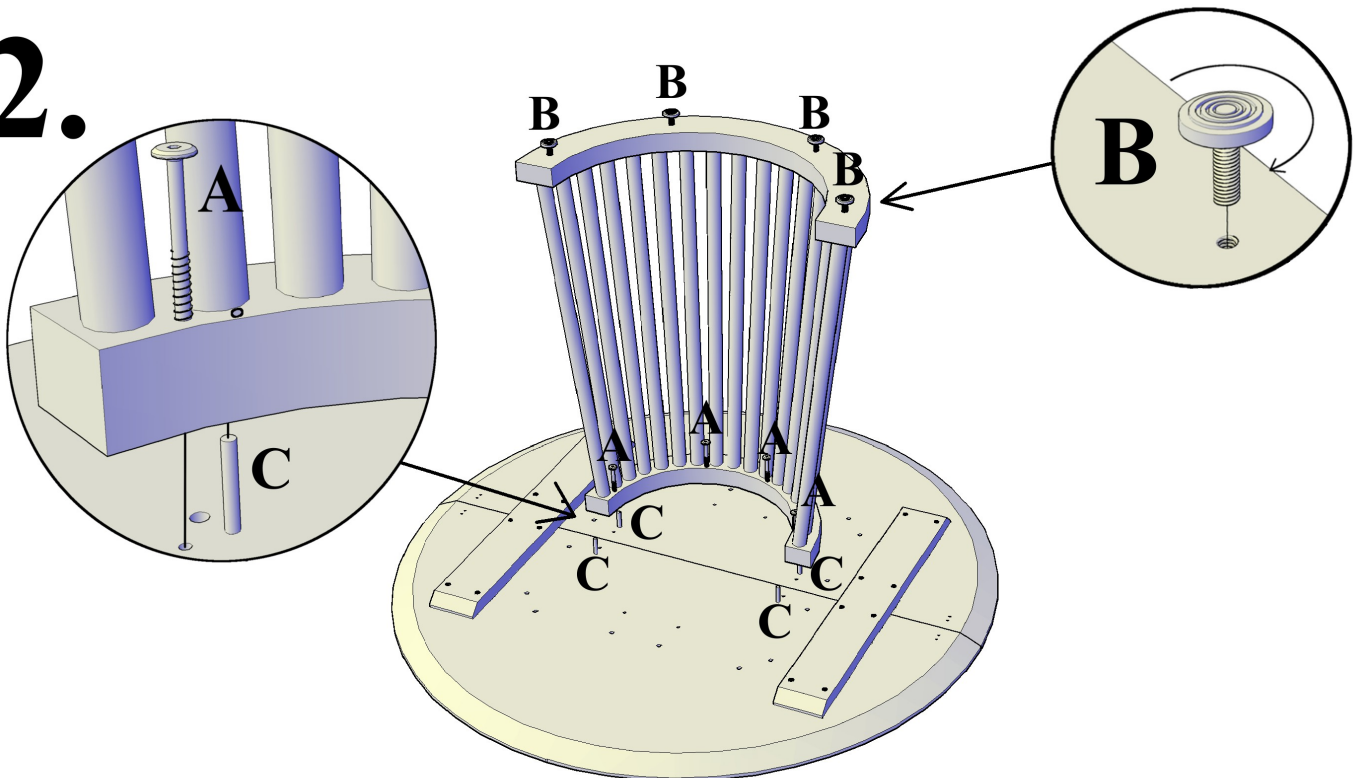

3.

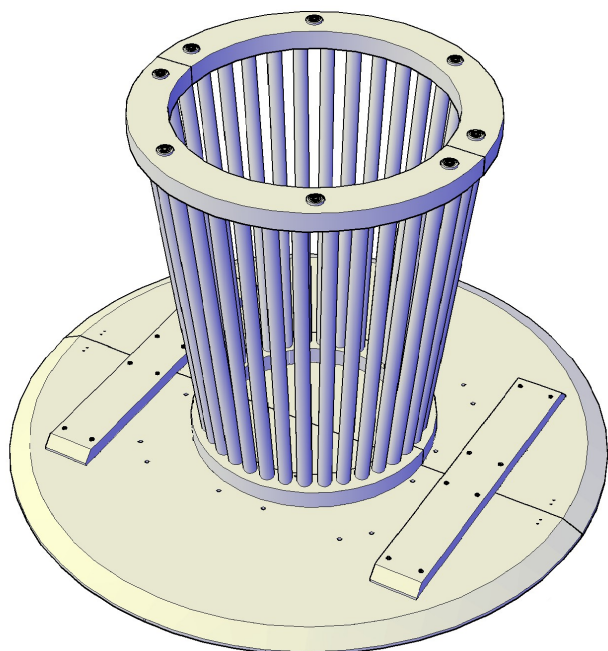

4.

